

# SOL-0306

## FEATURES

- Compact design for smaller spaces where a full-size skylight is not practical.
- True Blue-Sky illumination creates the appearance of natural daylight indoors.
- Sunlight-spectrum technology = high colour accuracy and visual comfort.
- DALI, app and control panel compatibility for flexible lighting control.
- Lightweight design allows easy integration into a wide range of ceiling types.
- Ideal as a standalone feature or as part of a multi-skylight arrangement. Premium aluminium construction for long-term durability and reliability.

## APPLICATIONS

Ideal for:

- Feature gallery lighting
- Residential feature ceilings
- Hotels and hospitality venues
- Wellness centres and spas
- Retail stores and showrooms
- Commercial reception areas
- Museums and exhibition

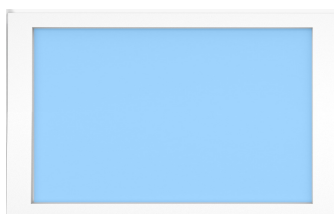

BLUE SKY

Basic Parameters	Details
Power	48W
Voltage	90-277Vac
Illumination	3500lux
CCT	2500-10000K
Ra	Ra98
Light Tilt	90°
Lifetime	50000H
Sky Effect	True Blue
Control Method	APP   Panel   DALI
IP	IP20

Basic Parameters	Details
Weight	4.5kg
Operating Temp.	-20~40°C
Shell Material	Aluminium Alloy
Surface Material	Tempered Glass
Sol Size	570*274*73mm
Sky Size	460*226mm
Hole Size	595*295mm
Ceiling Height	>200mm
Front Frame Size	600*300*8mm

## Product Ordering

PRODUCT CODE	PRODUCT TYPE	DIMENSIONS	ACCESSORIES
SOL-0306-B	BLUE SKY	300 X 600MM	Control panel, DALI driver

## DIMENSIONS

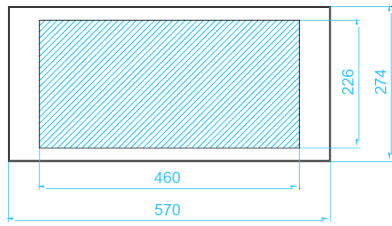

SOL

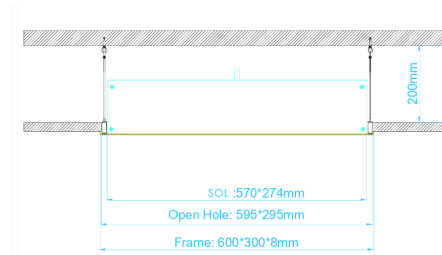

INSTALLATION

## MOUNTING OPTIONS

### RECESSED INSTALLATION

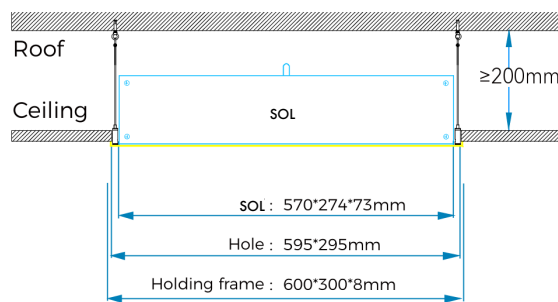

## ACCESSORIES



AC DRIVER & ANTENNA



CONTROL DRIVER



CONTROL PANEL

## CIRCUIT DIAGRAM

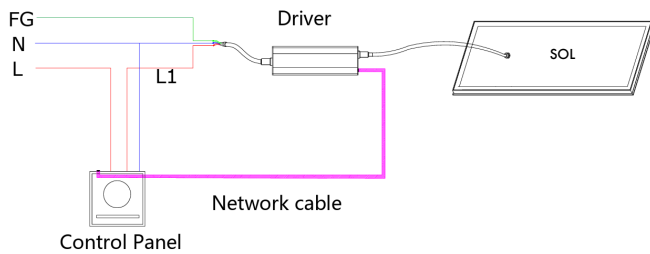

### Notes

- L (live wire)
- N (neutral wire)
- FG (GND)
- HDMI cable
- Network cable

## LIGHT MODES

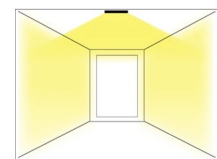

Turn on the Sky light

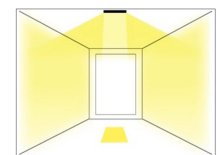

Turn on Sky light and Sun light